

## CURRENT SENSOR

---

PRODUCT SERIES: STK-HD/P

PRODUCT PART NUMBER: STK-05HD/P2  
STK-10HD/P1, STK-10HD/P2  
STK-15HD/P1, STK-15HD/P2  
STK-20HD/P1, STK-20HD/P2  
STK-25HD/P2, STK-30HD/P2  
STK-10HD/P2S, STK-20HD/P1S,  
STK-20HD/P2S, STK-30HD/P2S

REVISION: Ver 5.2

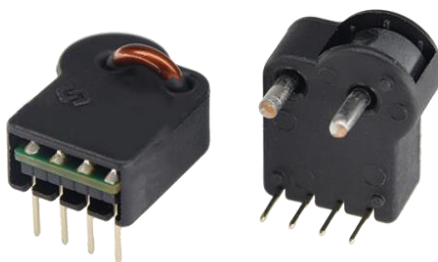

Sinomags Technology Co., Ltd.

Web site: [www.sinomags.com](http://www.sinomags.com)

## CONTENT

1.	Description .....	2
2.	Electrical performance of STK-05HD/ P2 .....	3
3.	Output voltage VS primary current of STK-05HD/ P2 .....	4
4.	Electrical performance of STK-10HD/P1 & P2 .....	5
5.	Output voltage VS primary current of STK-10HD/P1 & P2 .....	6
6.	Electrical performance of STK-15HD/P1 & P2 .....	7
7.	Output voltage VS primary current of STK-15HD/P1 & P2 .....	8
8.	Electrical performance of STK-20HD/P1 & P2 .....	9
9.	Output voltage VS primary current of STK-20HD/P1 & P2 .....	10
10.	Electrical performance of STK-25HD/ P2 .....	11
11.	Output voltage VS primary current of STK-25HD/ P2 .....	12
12.	Electrical performance of STK-30HD/ P2 .....	13
13.	Output voltage VS primary current of STK-30HD/ P2 .....	14
14.	Electrical performance of STK-10HD/P2S .....	15
15.	Output voltage VS primary current of STK-10HD/P2S .....	16
16.	Electrical performance of STK-20HD/P1S& P2S .....	17
17.	Output voltage VS primary current of STK-20HD/P1S& P2S .....	18
18.	Electrical performance of STK-30HD/P2S .....	19
19.	Output voltage VS primary current of STK-30HD/P2S .....	20
20.	Frequency band width .....	21
21.	Step response time .....	21
22.	Delaytime .....	22
23.	Temperature derating curve .....	22
24.	Accuracy performance .....	23
25.	Typical application circuits for STK-HD/Px .....	25
26.	Typical application circuits for STK-HD/PxS .....	26
27.	Dimensions & Pins & Footprint .....	27

## 1. Description

STK-HD/P current sensor is based on the open loop principle and TMR technology. DC, AC, pulses and any kind of irregularities wave can be measured by the current sensor under the isolated conditions.

### Typical application

- AC Variable speed drives
- PV string current detection
- Switched model power supplies (SMPS)
- Direct-current dynamo
- MPPT

### General parameters

Parameter	Symbol	Unit	Value
Working temperature	T <sub>A</sub>	°C	-40 ~ 105
Storage temperature	T <sub>stg</sub>	°C	-40 ~ 105
Mass	m	g	10

### Absolute parameters

Parameters	Symbol	Unit	Value
Supply voltage	V <sub>C</sub>	V	6
ESD rating (HBM)	U <sub>ESD</sub>	kV	4

Remark: the unrecoverable damage may occur when the product works on the conditions over the absolute maximum ratings. Long-time working on the absolute maximum ratings may cause the degradation on performance and reliability.

### Isolation parameters

Parameter	Symbol	Unit	Value	Remark
RMS voltage for AC test 50Hz/1 min	U <sub>d</sub>	kV	4	
Impulse withstand voltage 1.2/50μs	Ū <sub>w</sub>	kV	6	
Clearance distance (pri.-sec)	d <sub>Cl</sub>	mm	9.6	Shortest distance through air
Creepage distance (pri.-sec)	d <sub>Cp</sub>	mm	9.6	Shortest path along device body
Electrical clearance	-	mm	9	When mounted on PCB with recommended layout
Case material			V0 according to UL 94	
Comparative tracking index	CTI	V	600	

## 2. Electrical performance of STK-05HD/ P2

Parameter	Symbol	Unit	Min	Typ	Max	Comment
Primary nominal current rms	I <sub>pn</sub>	A		5		
Primary current measuring range	I <sub>pm</sub>	A	-12.5		12.5	
Supply voltage	V <sub>cc</sub>	V	4.75	5	5.25	
Current consumption	I <sub>cc</sub>	mA		5	10	
Reference voltage	V <sub>ref</sub>	V	2.47	2.5	2.53	Output function
Quiescent voltage V <sub>out</sub> @ 0 A	V <sub>off</sub>	V	2.47	2.5	2.53	
Electrical offset voltage (V <sub>out</sub> – V <sub>ref</sub> ) @ 0 A	V <sub>oe</sub>	mV	-30		30	
Rated output voltage ((V <sub>out</sub> – V <sub>ref</sub> )@I <sub>pn</sub> ) – V <sub>oe</sub>	V <sub>FS</sub>	V		0.8		
Internal output resistance	R <sub>out</sub>	Ω		1		
Internal reference resistance	R <sub>ref</sub>	Ω		1		
Theoretical gain	G	mV/A		160		
Rated linearity error	Non-L	%I <sub>pn</sub>		0.7		Within ±I <sub>pn</sub>
Reaction time	t <sub>ra</sub>	μs		0.5		@ 10% of I <sub>pn</sub>
Step response time	t <sub>res</sub>	μs		1.0		@ 90% of I <sub>pn</sub>
Delay time	t <sub>delay</sub>	μs		0.5		400 kHz sine wave
Frequency bandwidth (-3dB)	BW	kHz		600		No RC circuit
Output voltage noise DC ~ 10 kHz DC ~ 100 kHz	V <sub>noise</sub>	mVpp		8 10		@250kHz Sampling Rate
Accuracy @ 25°C	X	% of I <sub>pn</sub>	-1		1	@ 25°C
Accuracy @ -40°C~105°C	X <sub>TRange</sub>	% of I <sub>pn</sub>	-3		3	-40°C ~ 105°C

### Remarks:

- the accuracy @ -40°C~105°C, X<sub>TRange</sub> = (((V<sub>out</sub> – V<sub>ref</sub>)@ I<sub>n</sub> @ T<sub>x</sub>) – V<sub>oe</sub>@ 25°C – G<sub>th</sub> \* I<sub>n</sub>) / V<sub>FS</sub>, where T<sub>x</sub> represents present temperature, G<sub>th</sub> is fitted gain at room temperature.

### 3. Output voltage VS primary current of STK-05HD/ P2

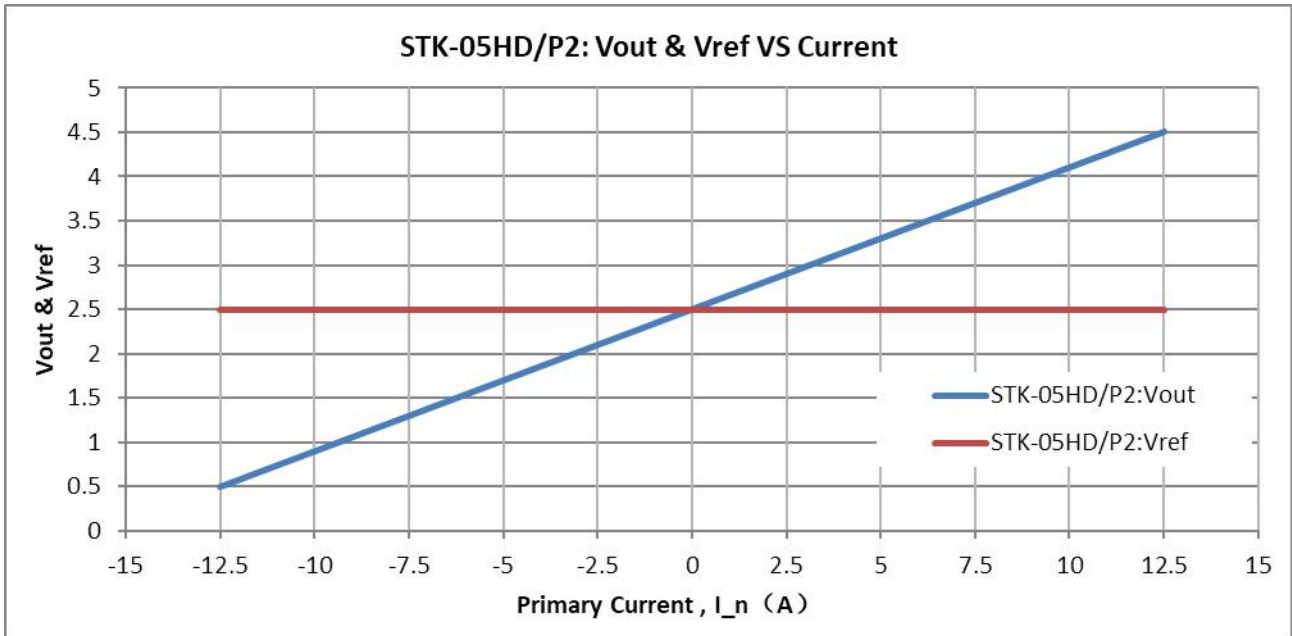

The dependence of Vout&Vref of STK-05HD/P2 on the primary current.

#### 4. Electrical performance of STK-10HD/P1 & P2

Parameter	Symbol	Unit	Min	Typ	Max	Comment
Primary nominal current rms	I <sub>pn</sub>	A		10		
Primary current measuring range	I <sub>pm</sub>	A	-10		10	STK-10HD/P1
			-25		25	STK-10HD/P2
Supply voltage	V <sub>cc</sub>	V	4.75	5	5.25	
Current consumption	I <sub>cc</sub>	mA		5	10	
Reference voltage	V <sub>ref</sub>	V	2.47	2.5	2.53	Output function
Quiescent voltage V <sub>out</sub> @ 0 A	V <sub>off</sub>	V	2.47	2.5	2.53	STK-10HD/P1 STK-10HD/P2
Electrical offset voltage (V <sub>out</sub> – V <sub>ref</sub> ) @ 0 A	V <sub>oe</sub>	mV	-30		30	STK-10HD/P1
			-20		20	STK-10HD/P2
Rated output voltage ((V <sub>out</sub> – V <sub>ref</sub> )@I <sub>pn</sub> ) – V <sub>oe</sub>	V <sub>FS</sub>	V		2		STK-10HD/P1
				0.8		STK-10HD/P2
Internal output resistance	R <sub>out</sub>	Ω		1		
Internal reference resistance	R <sub>ref</sub>	Ω		1		
Theoretical gain	G	mV/A		200		STK-10HD/P1
				80		STK-10HD/P2
Rated linearity error	Non-L	%I <sub>pn</sub>		0.7		Within ±I <sub>pn</sub>
Reaction time	t <sub>ra</sub>	μs		0.5		@ 10% of I <sub>pn</sub>
Step response time	t <sub>res</sub>	μs		1.0		@ 90% of I <sub>pn</sub>
Delay time	t <sub>delay</sub>	μs		0.5		400 kHz sine wave
Frequency bandwidth (-3dB)	BW	kHz		600		No RC circuit
Output voltage noise DC ~ 10 kHz DC ~ 100 kHz	V <sub>noise</sub>	mVpp		17 24		@250kHz Sampling Rate
Accuracy @ 25°C	X	% of I <sub>pn</sub>	-1		1	@ 25°C
Accuracy @ -40°C~105°C	X <sub>TRange</sub>	% of I <sub>pn</sub>	-3		3	-40°C ~ 105°C

Remarks:

- the accuracy @ -40°C~105°C, X<sub>TRange</sub> = (((V<sub>out</sub> – V<sub>ref</sub>)@ I<sub>n</sub> @ T<sub>x</sub>) – V<sub>oe</sub>@ 25°C – G<sub>th</sub> \* I<sub>n</sub>) / V<sub>FS</sub>, where T<sub>x</sub> represents present temperature, G<sub>th</sub> is fitted gain at room temperature.

## 5. Output voltage VS primary current of STK-10HD/P1 & P2

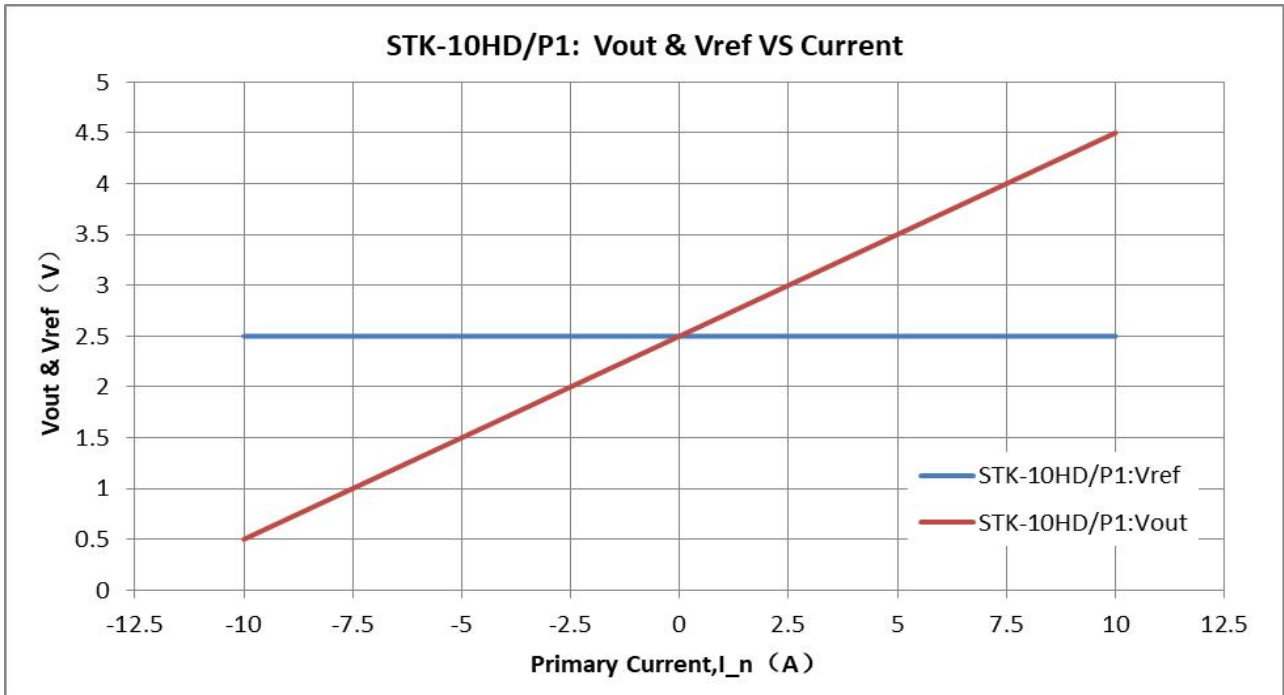

The dependence of Vout of STK-10HD/P1 on the primary current.

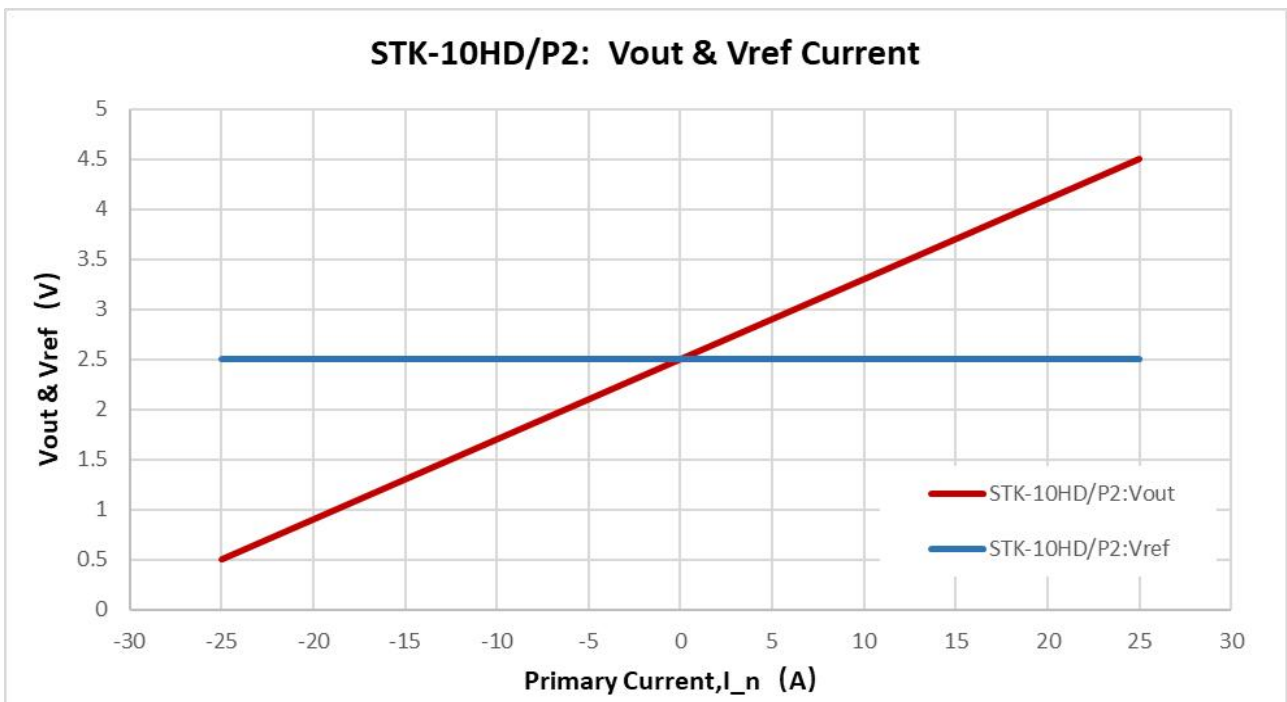

The dependence of Vout of STK-10HD/P2 on the primary current.

## 6. Electrical performance of STK-15HD/P1 & P2

Parameter	Symbol	Unit	Min	Typ	Max	Comment
Primary nominal current rms	I <sub>pn</sub>	A		15		
Primary current measuring range	I <sub>pm</sub>	A	-15		15	STK-15HD/P1
			-45		45	STK-15HD/P2
Supply voltage	V <sub>cc</sub>	V	4.75	5	5.25	
Current consumption	I <sub>cc</sub>	mA		5	10	
Reference voltage	V <sub>ref</sub>	V	2.47	2.5	2.53	Output function
Quiescent voltage V <sub>out</sub> @ 0 A	V <sub>off</sub>	V	2.47	2.5	2.53	STK-15HD/P1 STK-15HD/P2
Electrical offset voltage (V <sub>out</sub> – V <sub>ref</sub> ) @ 0 A	V <sub>oe</sub>	mV	-30		30	STK-15HD/P1
			-20		20	STK-15HD/P2
Rated output voltage ((V <sub>out</sub> – V <sub>ref</sub> )@I <sub>pn</sub> ) – V <sub>oe</sub>	V <sub>FS</sub>	V		2		STK-15HD/P1
				0.8		STK-15HD/P2
Internal output resistance	R <sub>out</sub>	Ω		1		
Internal reference resistance	R <sub>ref</sub>	Ω		1		
Theoretical gain	G	mV/A		133		STK-15HD/P1
				53		STK-15HD/P2
Rated linearity error	Non-L	%I <sub>pn</sub>		0.7		Within ±I <sub>pn</sub>
Reaction time	t <sub>ra</sub>	μs		0.5		@ 10% of I <sub>pn</sub>
Step response time	t <sub>res</sub>	μs		1.0		@ 90% of I <sub>pn</sub>
Delay time	t <sub>delay</sub>	μs		0.5		400 kHz sine wave
Frequency bandwidth (-3dB)	BW	kHz		600		No RC circuit
Output voltage noise DC ~ 10 kHz DC ~ 100 kHz	V <sub>noise</sub>	mVpp		17 24		@250kHz Sampling Rate
Accuracy @ 25°C	X	% of I <sub>pn</sub>	-1		1	@ 25°C
Accuracy @ -40°C~105°C	X <sub>TRange</sub>	% of I <sub>pn</sub>	-3		3	-40°C ~ 105°C

Remarks:

- the accuracy @ -40°C~105°C, X<sub>TRange</sub> = (((V<sub>out</sub> – V<sub>ref</sub>)@ I<sub>n</sub> @ T<sub>x</sub>) – V<sub>oe</sub>@ 25°C – G<sub>th</sub> \* I<sub>n</sub>) / V<sub>FS</sub>, where T<sub>x</sub> represents present temperature, G<sub>th</sub> is fitted gain at room temperature.



## 7. Output voltage VS primary current of STK-15HD/P1 & P2

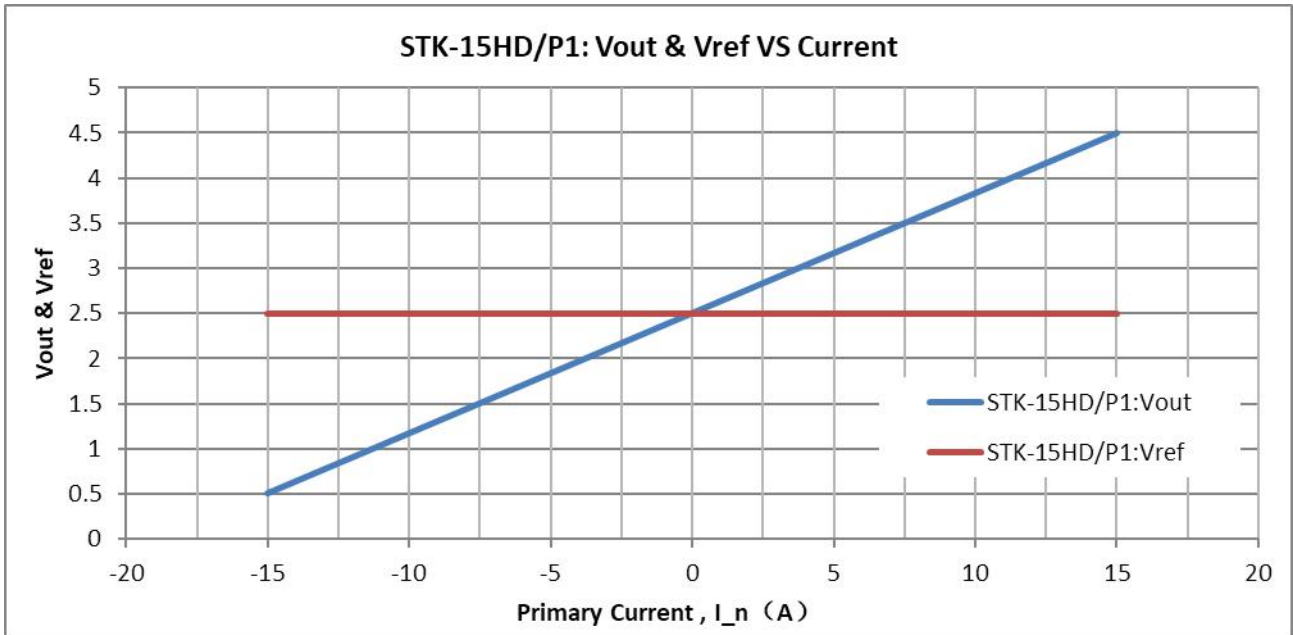

The dependence of Vout of STK-15HD/P1 on the primary current.

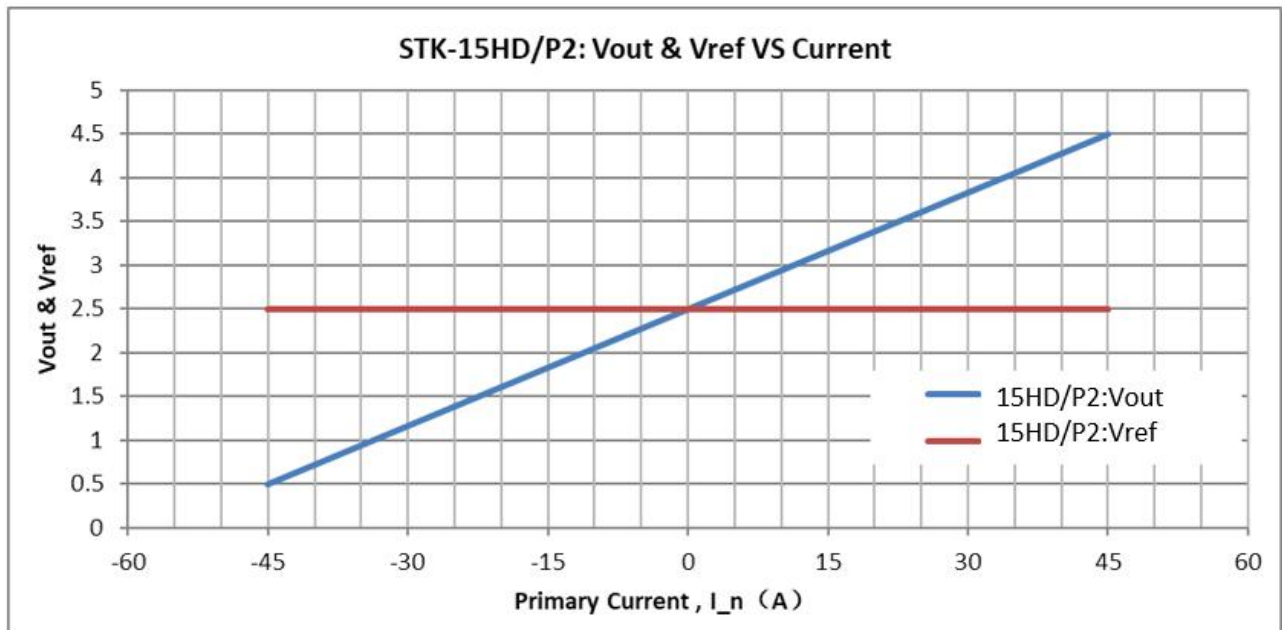

The dependence of Vout of STK-15HD/P2 on the primary current.

## 8. Electrical performance of STK-20HD/P1 & P2

Parameter	Symbol	Unit	Min	Typ	Max	Comment
Primary nominal current rms	I <sub>pn</sub>	A		20		
Primary current measuring range	I <sub>pm</sub>	A	-20		20	STK-20HD/P1
			-50		50	STK-20HD/P2
Supply voltage	V <sub>cc</sub>	V	4.75	5	5.25	
Current consumption	I <sub>cc</sub>	mA		5	10	
Reference voltage	V <sub>ref</sub>	V	2.47	2.5	2.53	Output function
Quiescent voltage V <sub>out</sub> @ 0 A	V <sub>off</sub>	V	2.47	2.5	2.53	STK-20HD/P1 STK-20HD/P2
Electrical offset voltage (V <sub>out</sub> – V <sub>ref</sub> ) @ 0 A	V <sub>oe</sub>	mV	-30		30	STK-20HD/P1
			-20		20	STK-20HD/P2
Rated output voltage ((V <sub>out</sub> – V <sub>ref</sub> )@I <sub>pn</sub> ) – V <sub>oe</sub>	V <sub>FS</sub>	V		2		STK-20HD/P1
				0.8		STK-20HD/P2
Internal output resistance	R <sub>out</sub>	Ω		1		
Internal reference resistance	R <sub>ref</sub>	Ω		1		
Theoretical gain	G	mV/A		100		STK-20HD/P1
				40		STK-20HD/P2
Rated linearity error	Non-L	%I <sub>pn</sub>		0.7		Within ±I <sub>pn</sub>
Reaction time	t <sub>ra</sub>	μs		0.5		@ 10% of I <sub>pn</sub>
Step response time	t <sub>res</sub>	μs		1.0		@ 90% of I <sub>pn</sub>
Delay time	t <sub>delay</sub>	μs		0.5		400 kHz sine wave
Frequency bandwidth (-3dB)	BW	kHz		600		No RC circuit
Output voltage noise DC ~ 10 kHz DC ~ 100 kHz	V <sub>noise</sub>	mVpp		15 20		@250kHz Sampling Rate
Accuracy @ 25°C	X	% of I <sub>pn</sub>	-1		1	@ 25°C
Accuracy @ -40°C~105°C	X <sub>TRange</sub>	% of I <sub>pn</sub>	-3		3	-40°C ~ 105°C

### Remarks:

- the accuracy @ -40°C~105°C, X<sub>TRange</sub> = (((V<sub>out</sub> – V<sub>ref</sub>)@ I<sub>n</sub> @ T<sub>x</sub>) – V<sub>oe</sub>@ 25°C – G<sub>th</sub> \* I<sub>n</sub>) / V<sub>FS</sub>, where T<sub>x</sub> represents present temperature, G<sub>th</sub> is fitted gain at room temperature.

## 9. Output voltage VS primary current of STK-20HD/P1 & P2

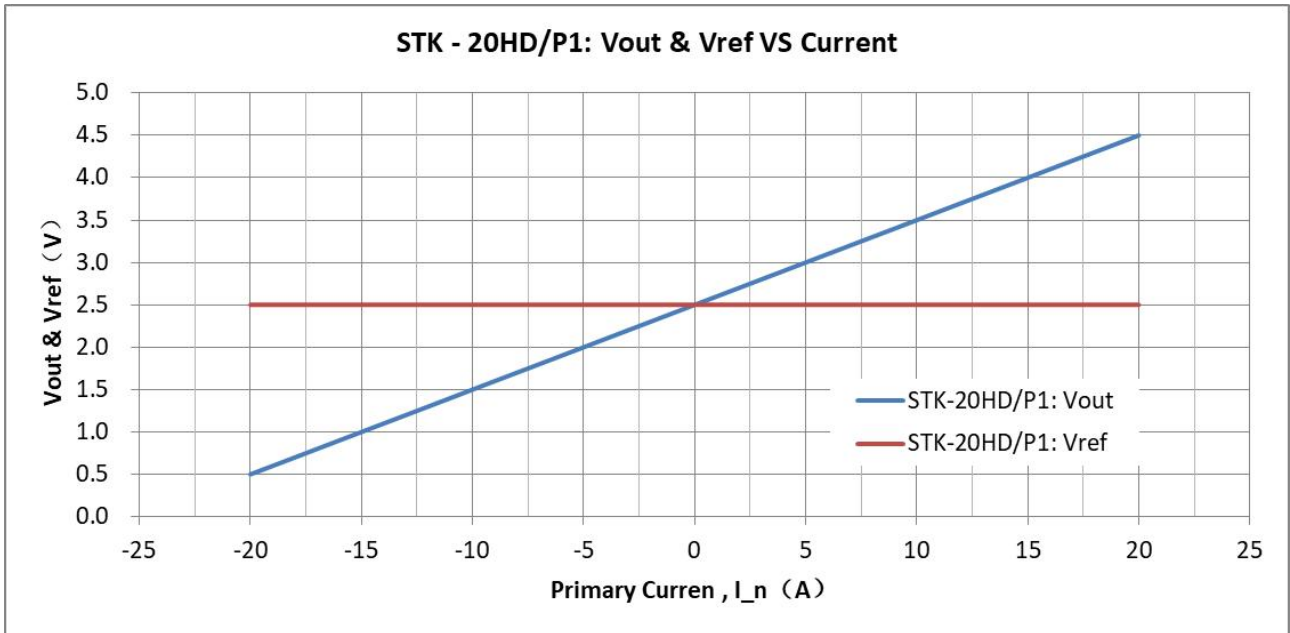

The dependence of Vout of STK-20HD/P1 on the primary current.

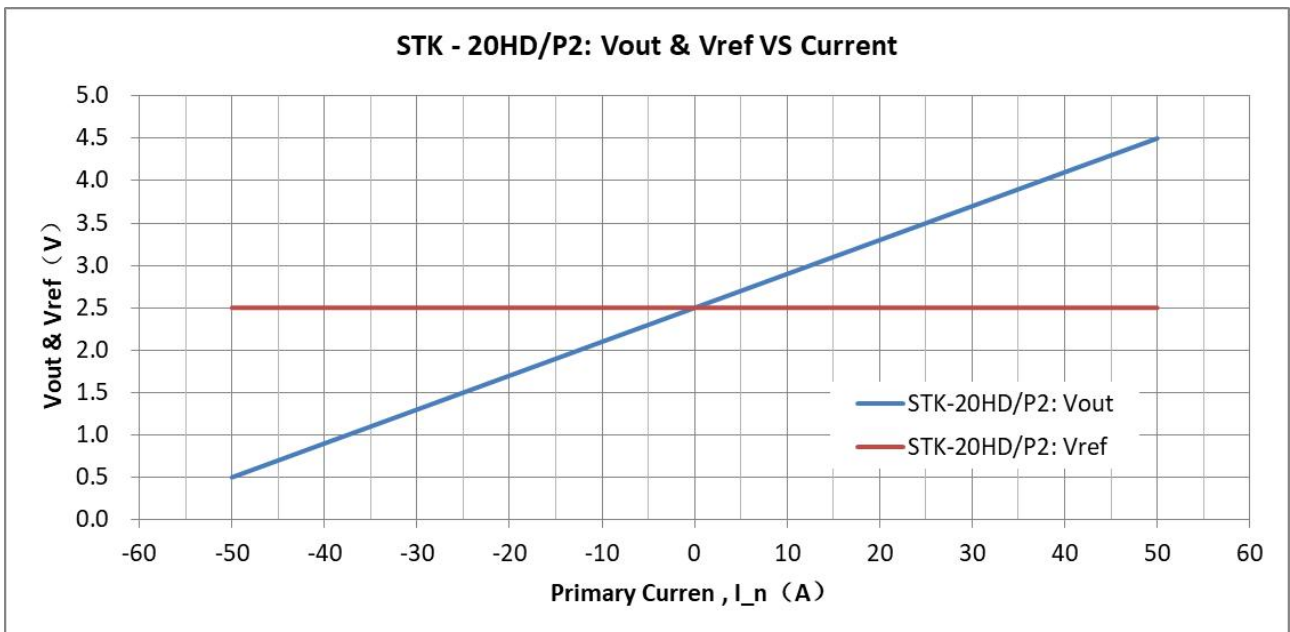

The dependence of Vout of STK-20HD/P2 on the primary current.

## 10. Electrical performance of STK-25HD/ P2

Parameter	Symbol	Unit	Min	Typ	Max	Comment
Primary nominal current rms	I <sub>pn</sub>	A		25		
Primary current measuring range	I <sub>pm</sub>	A	-62.5		62.5	
Supply voltage	V <sub>cc</sub>	V	4.75	5	5.25	
Current consumption	I <sub>cc</sub>	mA		5	10	
Reference voltage	V <sub>ref</sub>	V	2.47	2.5	2.53	Output function
Quiescent voltage V <sub>out</sub> @ 0 A	V <sub>off</sub>	V	2.47	2.5	2.53	
Electrical offset voltage (V <sub>out</sub> – V <sub>ref</sub> ) @ 0 A	V <sub>oe</sub>	mV	-30		30	
Rated output voltage ((V <sub>out</sub> – V <sub>ref</sub> )@I <sub>pn</sub> ) – V <sub>oe</sub>	V <sub>FS</sub>	V		0.8		
Internal output resistance	R <sub>out</sub>	Ω		1		
Internal reference resistance	R <sub>ref</sub>	Ω		1		
Theoretical gain	G	mV/A		32		
Rated linearity error	Non-L	%I <sub>pn</sub>		0.7		Within ±I <sub>pn</sub>
Reaction time	t <sub>ra</sub>	μs		0.5		@ 10% of I <sub>pn</sub>
Step response time	t <sub>res</sub>	μs		1.0		@ 90% of I <sub>pn</sub>
Delay time	t <sub>delay</sub>	μs		0.5		400 kHz sine wave
Frequency bandwidth (-3dB)	BW	kHz		600		No RC circuit
Output voltage noise DC ~ 10 kHz DC ~ 100 kHz	V <sub>noise</sub>	mVpp		8 10		@250kHz Sampling Rate
Accuracy @ 25°C	X	% of I <sub>pn</sub>	-1		1	@ 25°C
Accuracy @ -40°C~105°C	X <sub>TRange</sub>	% of I <sub>pn</sub>	-3		3	-40°C ~ 105°C

### Remarks:

- the accuracy @ -40°C~105°C, X<sub>TRange</sub> = (((V<sub>out</sub> – V<sub>ref</sub>)@ I<sub>n</sub> @ T<sub>x</sub>) – V<sub>oe</sub>@ 25°C – G<sub>th</sub> \* I<sub>n</sub>) / V<sub>FS</sub>, where T<sub>x</sub> represents present temperature, G<sub>th</sub> is fitted gain at room temperature.

## 11. Output voltage VS primary current of STK-25HD/ P2

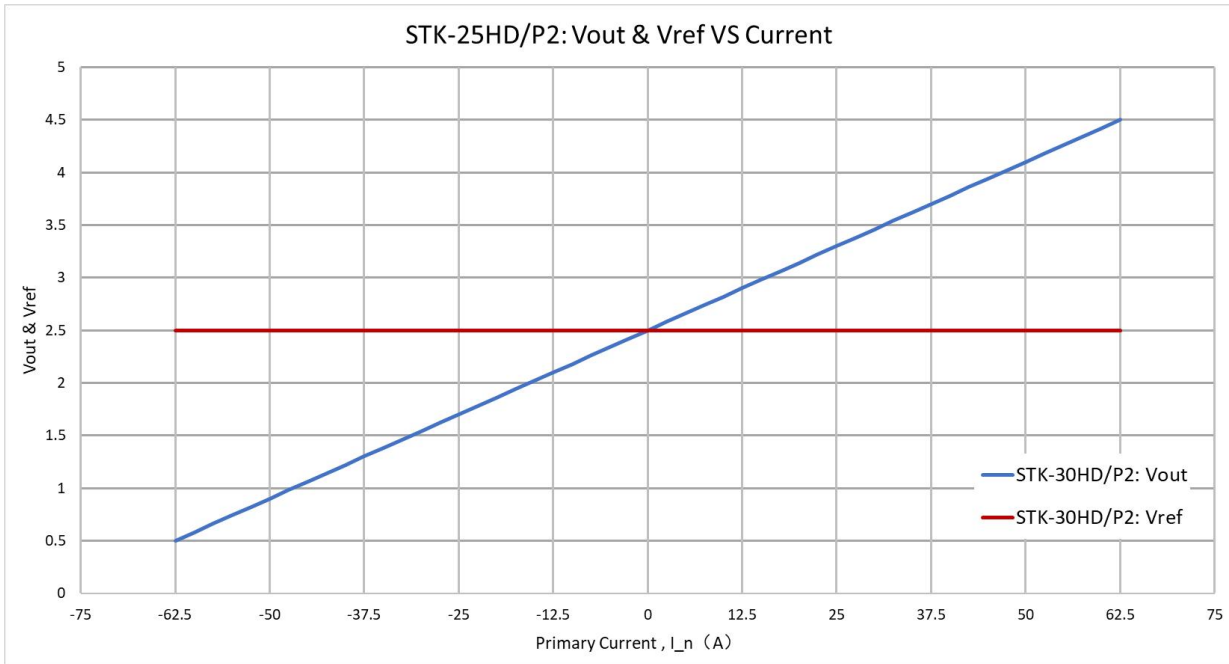

The dependence of Vout&Vref of STK-25HD/P2 on the primary current.

## 12. Electrical performance of STK-30HD/ P2

Parameter	Symbol	Unit	Min	Typ	Max	Comment
Primary nominal current rms	I <sub>pn</sub>	A		30		
Primary current measuring range	I <sub>pm</sub>	A	-75		75	
Supply voltage	V <sub>cc</sub>	V	4.75	5	5.25	
Current consumption	I <sub>cc</sub>	mA		5	10	
Reference voltage	V <sub>ref</sub>	V	2.47	2.5	2.53	Output function
Quiescent voltage V <sub>out</sub> @ 0 A	V <sub>off</sub>	V	2.47	2.5	2.53	
Electrical offset voltage (V <sub>out</sub> – V <sub>ref</sub> ) @ 0 A	V <sub>oe</sub>	mV	-30		30	
Rated output voltage ((V <sub>out</sub> – V <sub>ref</sub> )@I <sub>pn</sub> ) – V <sub>oe</sub>	V <sub>FS</sub>	V		0.8		
Internal output resistance	R <sub>out</sub>	Ω		1		
Internal reference resistance	R <sub>ref</sub>	Ω		1		
Theoretical gain	G	mV/A		26.7		
Rated linearity error	Non-L	%I <sub>pn</sub>		0.7		Within ±I <sub>pn</sub>
Reaction time	t <sub>ra</sub>	μs		0.5		@ 10% of I <sub>pn</sub>
Step response time	t <sub>res</sub>	μs		1.0		@ 90% of I <sub>pn</sub>
Delay time	t <sub>delay</sub>	μs		0.5		400 kHz sine wave
Frequency bandwidth (-3dB)	BW	kHz		600		No RC circuit
Output voltage noise DC ~ 10 kHz DC ~ 100 kHz	V <sub>noise</sub>	mVpp		8 10		@250kHz Sampling Rate
Accuracy @ 25°C	X	% of I <sub>pn</sub>	-1		1	@ 25°C
Accuracy @ -40°C~105°C	X <sub>TRange</sub>	% of I <sub>pn</sub>	-3		3	-40°C ~ 105°C

### Remarks:

- the accuracy @ -40°C~105°C, X<sub>TRange</sub> = (((V<sub>out</sub> – V<sub>ref</sub>)@ I<sub>n</sub> @ T<sub>x</sub>) – V<sub>oe</sub>@ 25°C – G<sub>th</sub> \* I<sub>n</sub>) / V<sub>FS</sub>, where T<sub>x</sub> represents present temperature, G<sub>th</sub> is fitted gain at room temperature.

### 13. Output voltage VS primary current of STK-30HD/ P2

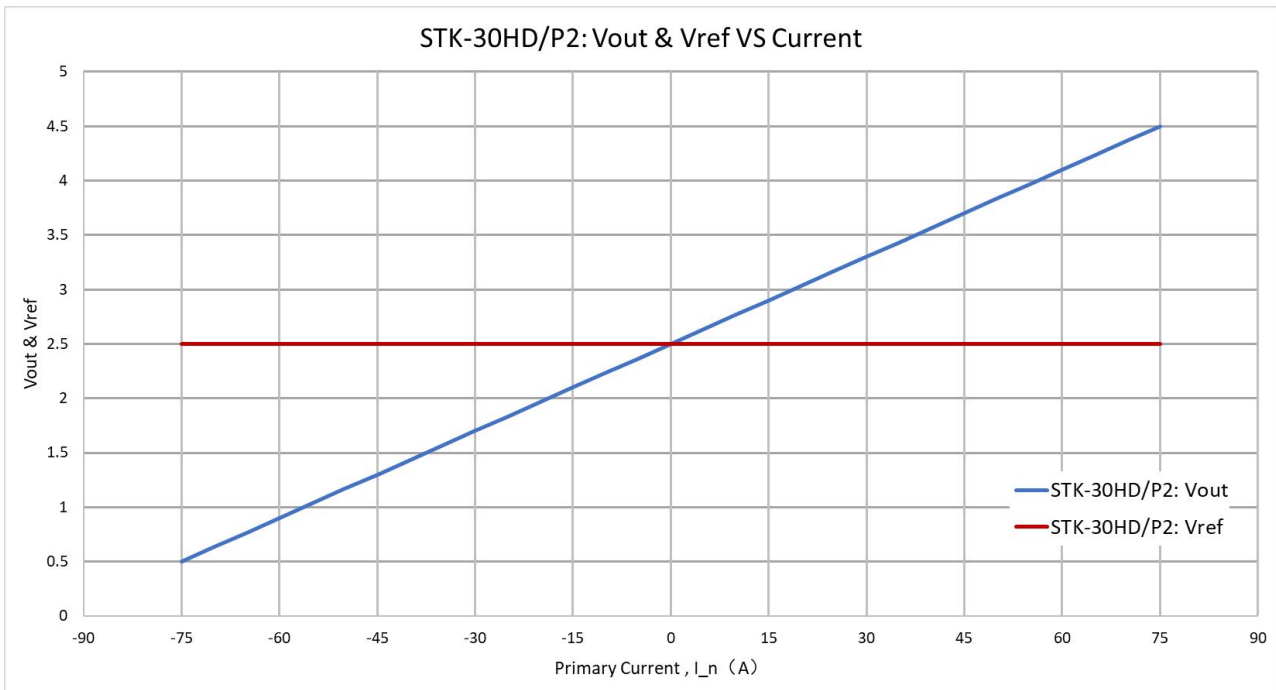

The dependence of Vout&Vref of STK-30HD/P2 on the primary current.

## 14. Electrical performance of STK-10HD/P2S

Parameter	Symbol	Unit	Min	Typ	Max	Comment
Primary nominal current rms	I <sub>pn</sub>	A		10		
Primary current measuring range	I <sub>pm</sub>	A	-30		30	STK-10HD/P2S
Supply voltage	V <sub>cc</sub>	V		3.3		3.3 V ±5%
Current consumption	I <sub>cc</sub>	mA		5	10	
Reference voltage	V <sub>ref</sub>	V	1.63	1.65	1.67	Output function
Quiescent voltage V <sub>out</sub> @ 0 A	V <sub>off</sub>	V	1.62	1.65	1.68	STK-10HD/P2S
Electrical offset voltage (V <sub>out</sub> – V <sub>refc</sub> ) @ 0 A	V <sub>oe</sub>	mV	-30		30	
			-30		30	
Rated output voltage (V <sub>out</sub> @ I <sub>pn</sub> – V <sub>refc</sub> ) – V <sub>oe</sub>	V <sub>FS</sub>	V		0.5		STK-10HD/P2S
Internal output resistance	R <sub>out</sub>	Ω		1		
Internal reference resistance	R <sub>ref</sub>	Ω		1		
Theoretical gain	G	mV/A		50		STK-10HD/P2S
Rated linearity error	Non-L	%I <sub>pn</sub>		0.7		Within ±I <sub>pn</sub>
Reaction time	t <sub>ra</sub>	μs		0.5		@ 10% of I <sub>pn</sub>
Step response time	t <sub>res</sub>	μs		1.0		@ 90% of I <sub>pn</sub>
Delay time	t <sub>delay</sub>	μs		0.5		400 kHz sine wave
Frequency bandwidth (-3dB)	BW	kHz		600		No RC circuit
Output voltage noise DC ~ 10 kHz DC ~ 100 kHz	V <sub>noise</sub>	mVpp		15 20		@250kHz Sampling Rate
Accuracy @ 25°C	X	% of I <sub>pn</sub>	-1		1	@ 25°C
Accuracy @ -40°C~105°C	X <sub>TRange</sub>	% of I <sub>pn</sub>	-3		3	-40°C ~ 105°C

### Remarks:

- The value of V<sub>refc</sub> is just for the purpose of calculation, is not a real output value.
- The accuracy @ -40°C~105°C, X<sub>TRange</sub> = (((V<sub>out</sub> – V<sub>refc</sub>)@ I<sub>n</sub> @ T<sub>x</sub>) – V<sub>oe</sub>@ 25°C – G<sub>th</sub> \* I<sub>n</sub>) / V<sub>FS</sub>, where T<sub>x</sub> represents present temperature, G<sub>th</sub> is fitted gain at room temperature.



### 15. Output voltage VS primary current of STK-10HD/P2S

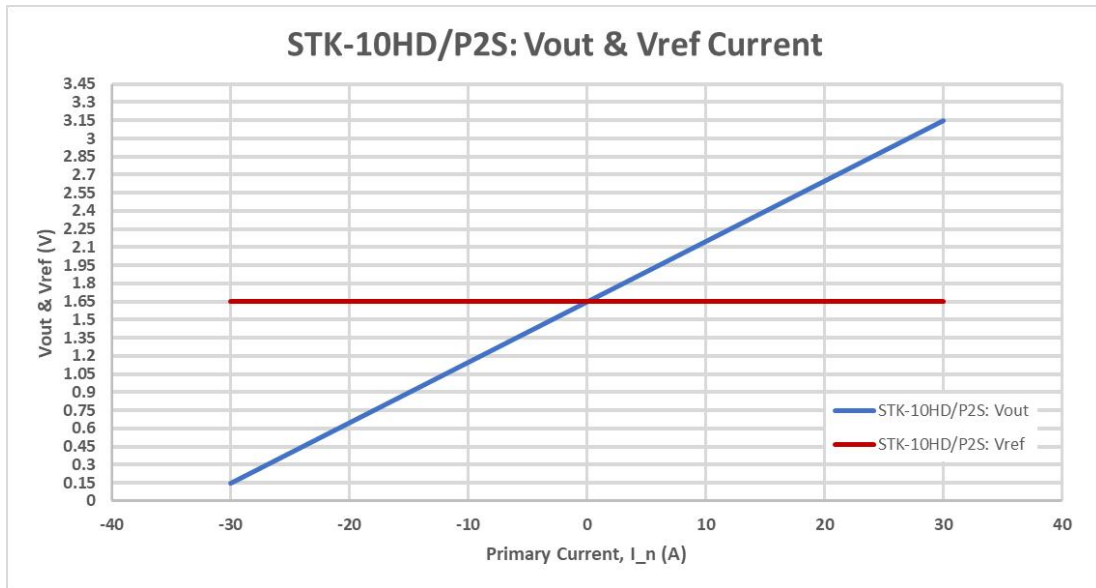

The dependence of Vout of STK-10HD/P2S on the primary current.

## 16. Electrical performance of STK-20HD/P1S& P2S

Parameter	Symbol	Unit	Min	Typ	Max	Comment
Primary nominal current rms	I <sub>pn</sub>	A		20		
Primary current measuring range	I <sub>pm</sub>	A	-20		20	STK-20HD/P1S
			-50		50	STK-20HD/P2S
Supply voltage	V <sub>cc</sub>	V		3.3		3.3 V ±5%
Current consumption	I <sub>cc</sub>	mA		5	10	
Reference voltage	V <sub>ref</sub>	V	1.63	1.65	1.67	Output function
Quiescent voltage V <sub>out</sub> @ 0 A	V <sub>off</sub>	V	1.62	1.65	1.68	STK-20HD/P1S STK-20HD/P2S
Electrical offset voltage (V <sub>out</sub> – V <sub>refc</sub> ) @ 0 A	V <sub>oe</sub>	mV	-30		30	
			-30		30	
Rated output voltage (V <sub>out</sub> @ I <sub>pn</sub> – V <sub>refc</sub> ) – V <sub>oe</sub>	V <sub>FS</sub>	V		1.25		STK-20HD/P1S
				0.5		STK-20HD/P2S
Internal output resistance	R <sub>out</sub>	Ω		1		
Internal reference resistance	R <sub>ref</sub>	Ω		1		
Theoretical gain	G	mV/A		62.5		STK-20HD/P1S
				25		STK-20HD/P2S
Rated linearity error	Non-L	%I <sub>pn</sub>		0.7		Within ±I <sub>pn</sub>
Reaction time	t <sub>ra</sub>	μs		0.5		@ 10% of I <sub>pn</sub>
Step response time	t <sub>res</sub>	μs		1.0		@ 90% of I <sub>pn</sub>
Delay time	t <sub>delay</sub>	μs		0.5		400 kHz sine wave
Frequency bandwidth (-3dB)	BW	kHz		600		No RC circuit
Output voltage noise DC ~ 10 kHz DC ~ 100 kHz	V <sub>noise</sub>	mVpp		15 20		@250kHz Sampling Rate
Accuracy @ 25°C	X	% of I <sub>pn</sub>	-1		1	@ 25°C
Accuracy @ -40°C~105°C	X <sub>TRange</sub>	% of I <sub>pn</sub>	-3		3	-40°C ~ 105°C

### Remarks:

- The value of V<sub>refc</sub> is just for the purpose of calculation, is not a real output value.
- The accuracy @ -40°C~105°C, X<sub>TRange</sub> = (((V<sub>out</sub> – V<sub>refc</sub>)@ I<sub>n</sub> @ T<sub>x</sub>) – V<sub>oe</sub>@ 25°C – G<sub>th</sub> \* I<sub>n</sub>) / V<sub>FS</sub>, where T<sub>x</sub> represents present temperature, G<sub>th</sub> is fitted gain at room temperature.

### 17. Output voltage VS primary current of STK-20HD/P1S& P2S

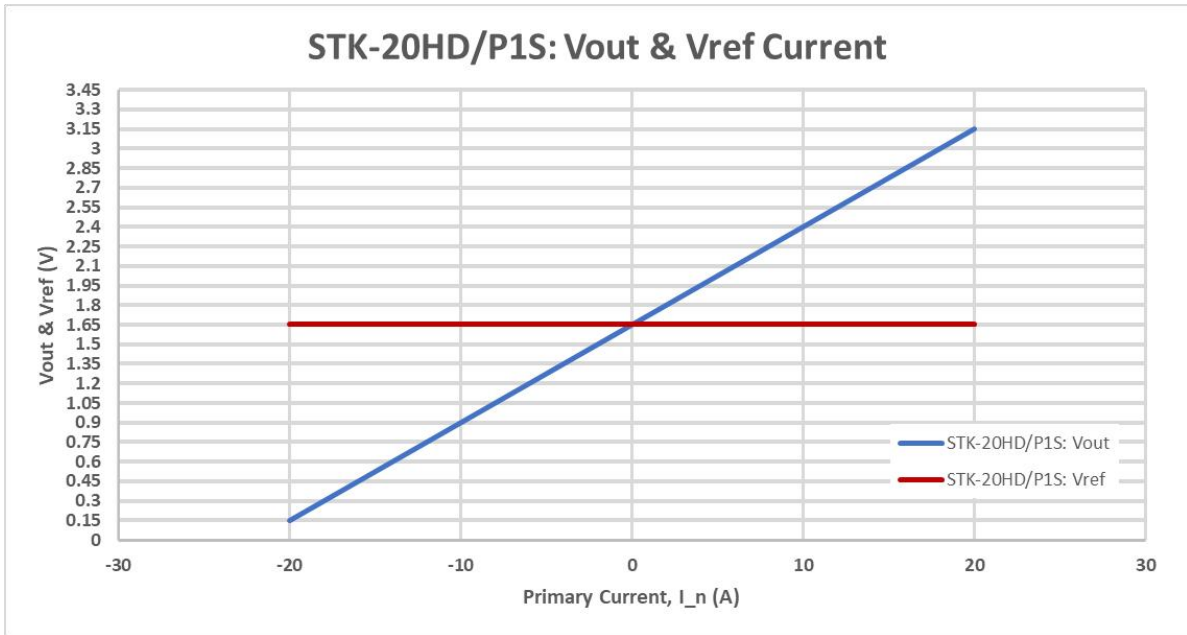

The dependence of Vout of STK-20HD/P1S on the primary current.

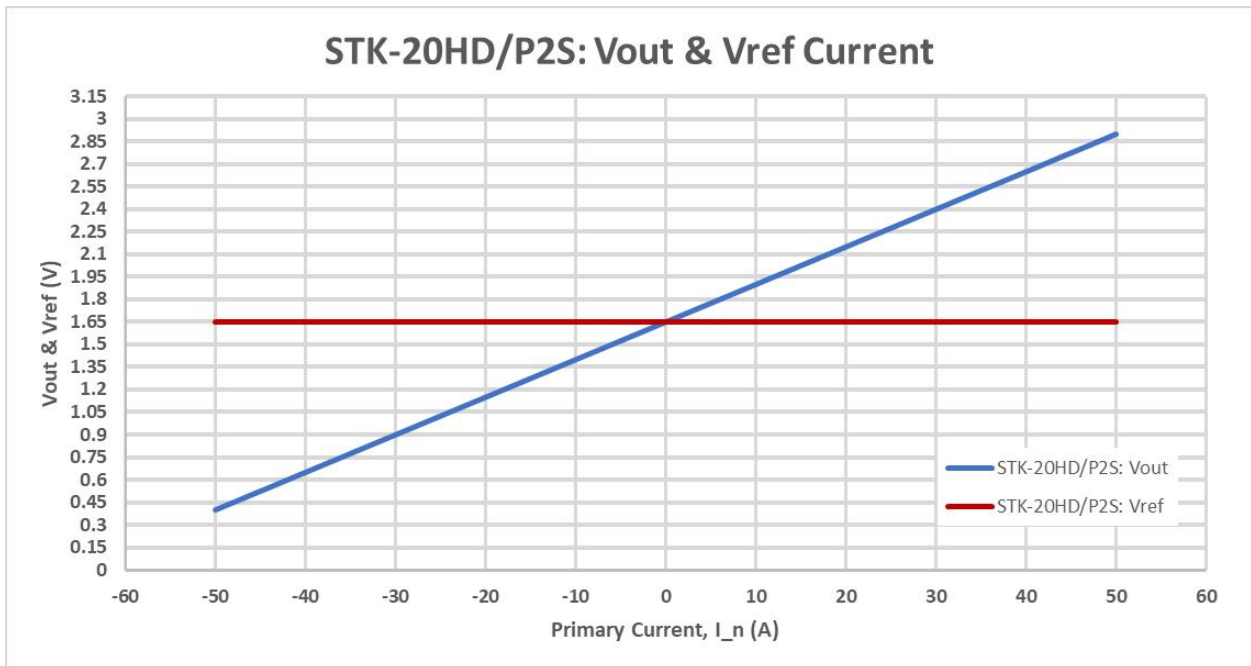

The dependence of Vout of STK-20HD/P2S on the primary current.

## 18. Electrical performance of STK-30HD/P2S

Parameter	Symbol	Unit	Min	Typ	Max	Comment
Primary nominal current rms	I <sub>pn</sub>	A		30		
Primary current measuring range	I <sub>pm</sub>	A	-75		75	STK-30HD/P2S
Supply voltage	V <sub>cc</sub>	V		3.3		3.3 V ±5%
Current consumption	I <sub>cc</sub>	mA		5	10	
Reference voltage	V <sub>ref</sub>	V	1.63	1.65	1.67	Output function
Quiescent voltage V <sub>out</sub> @ 0 A	V <sub>off</sub>	V	1.62	1.65	1.68	STK-30HD/P2S
Electrical offset voltage (V <sub>out</sub> – V <sub>refc</sub> ) @ 0 A	V <sub>oe</sub>	mV	-30		30	
Rated output voltage (V <sub>out</sub> @ I <sub>pn</sub> – V <sub>refc</sub> ) – V <sub>oe</sub>	V <sub>FS</sub>	V		0.5		STK-30HD/P2S
Internal output resistance	R <sub>out</sub>	Ω		1		
Internal reference resistance	R <sub>ref</sub>	Ω		1		
Theoretical gain	G	mV/A		16.7		STK-30HD/P2S
Rated linearity error	Non-L	%I <sub>pn</sub>		0.7		Within ±I <sub>pn</sub>
Reaction time	t <sub>ra</sub>	μs		0.5		@ 10% of I <sub>pn</sub>
Step response time	t <sub>res</sub>	μs		1.0		@ 90% of I <sub>pn</sub>
Delay time	t <sub>delay</sub>	μs		0.5		400 kHz sine wave
Frequency bandwidth (-3dB)	BW	kHz		600		No RC circuit
Output voltage noise DC ~ 10 kHz DC ~ 100 kHz	V <sub>noise</sub>	mVpp		15 20		@250kHz Sampling Rate
Accuracy @ 25°C	X	% of I <sub>pn</sub>	-1		1	@ 25°C
Accuracy @ -40°C~105°C	X <sub>TRange</sub>	% of I <sub>pn</sub>	-3		3	-40°C ~ 105°C

### Remarks:

- The value of V<sub>refc</sub> is just for the purpose of calculation, is not a real output value.
- The accuracy @ -40°C~105°C, X<sub>TRange</sub> = (((V<sub>out</sub> – V<sub>refc</sub>)@ I<sub>n</sub> @ T<sub>x</sub>) – V<sub>oe</sub>@ 25°C – G<sub>th</sub> \* I<sub>n</sub>) / V<sub>FS</sub>, where T<sub>x</sub> represents present temperature, G<sub>th</sub> is fitted gain at room temperature.

### 19. Output voltage VS primary current of STK-30HD/P2S

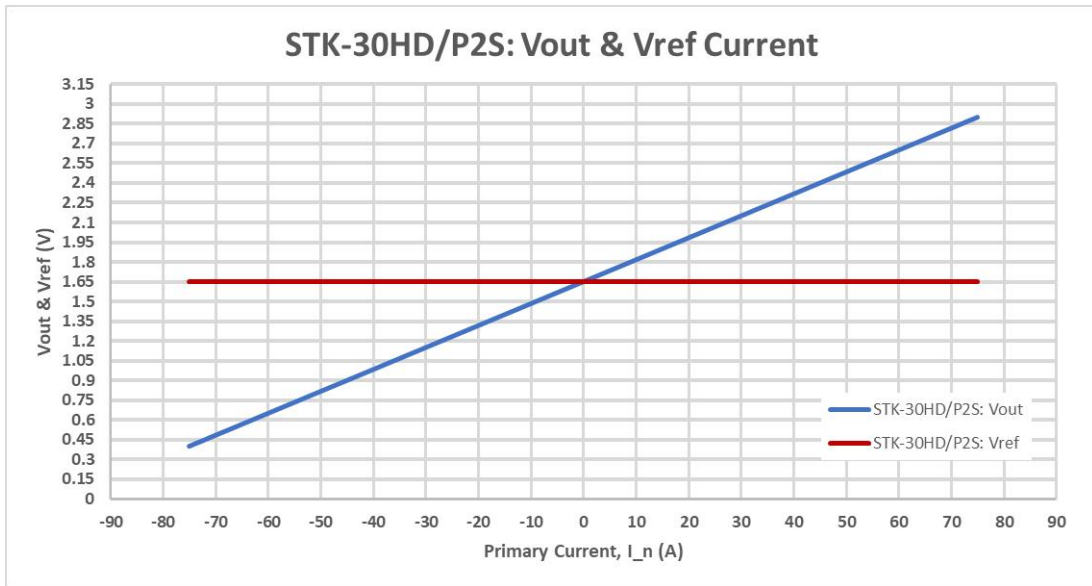

The dependence of Vout of STK-30HD/P2S on the primary current.

## 20. Frequency band width

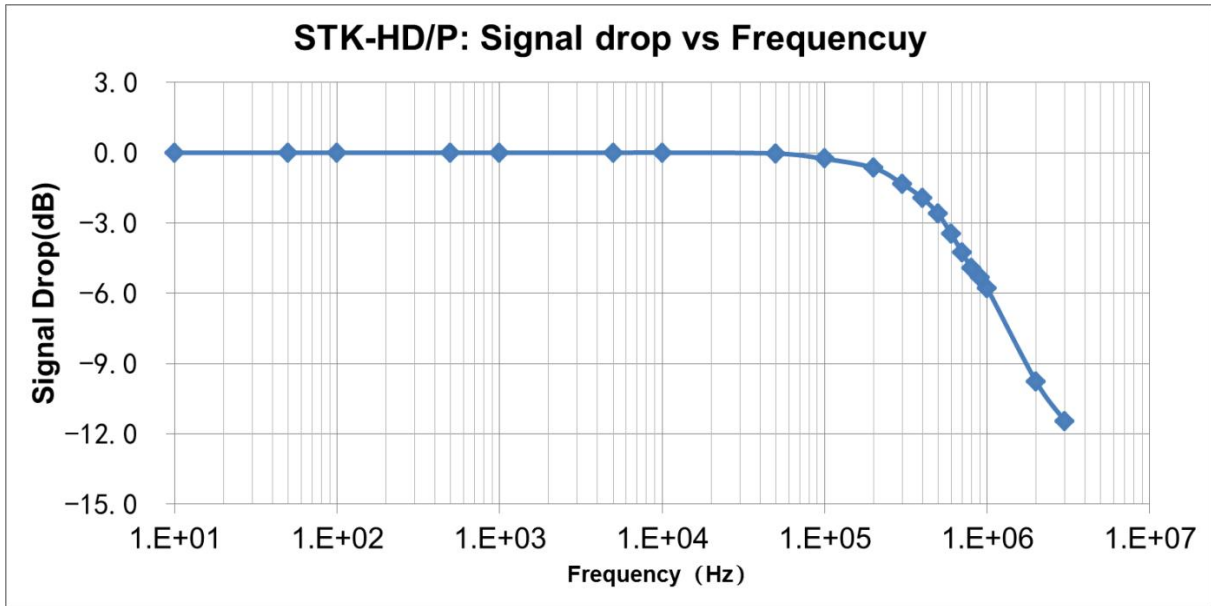

Fig.1 the frequency band width of STK-HD/P series current sensors.

## 21. Step response time

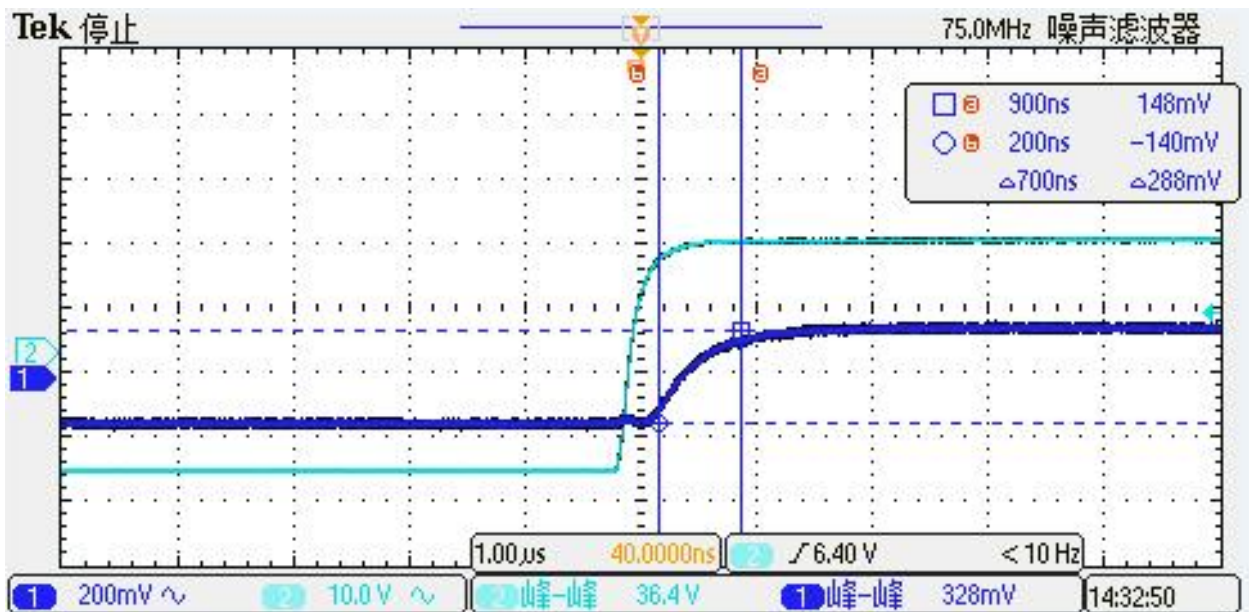

Fig.2 the step response time of STK-HD/P current sensors. The light blue is primary current, while the dark blue is output signal of current sensor. The step response time is less than 1.0µs.

## 22. Delaytime

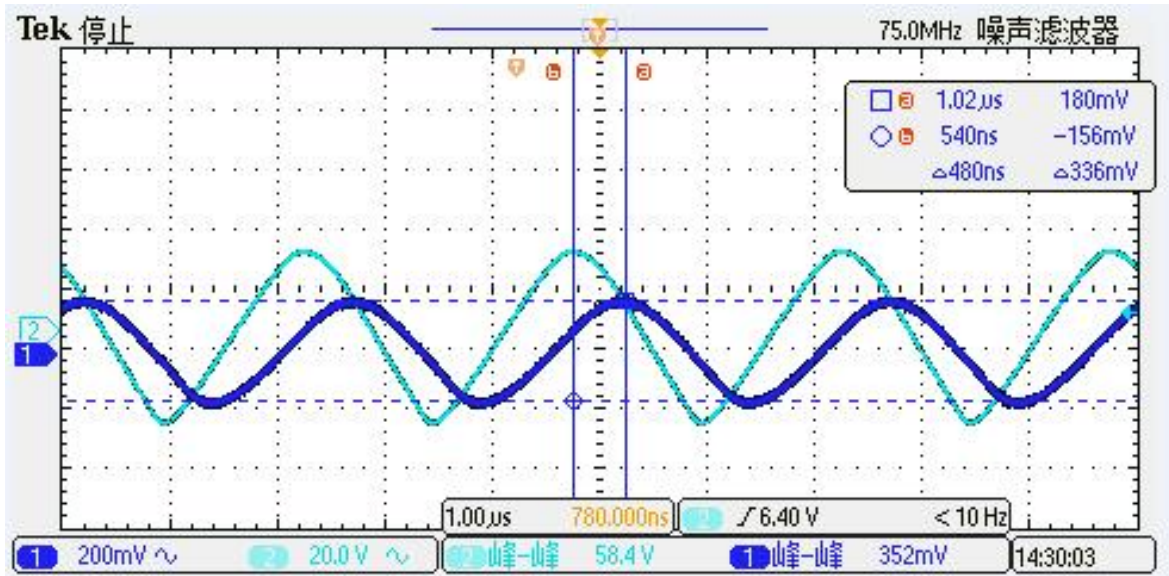

Fig.3 when detection the primary current with a frequency of 400 kHz. The delay time from the primary current (light blue) to the output of the sensor (dark blue) is around 0.5  $\mu$ s.

## 23. Temperature derating curve

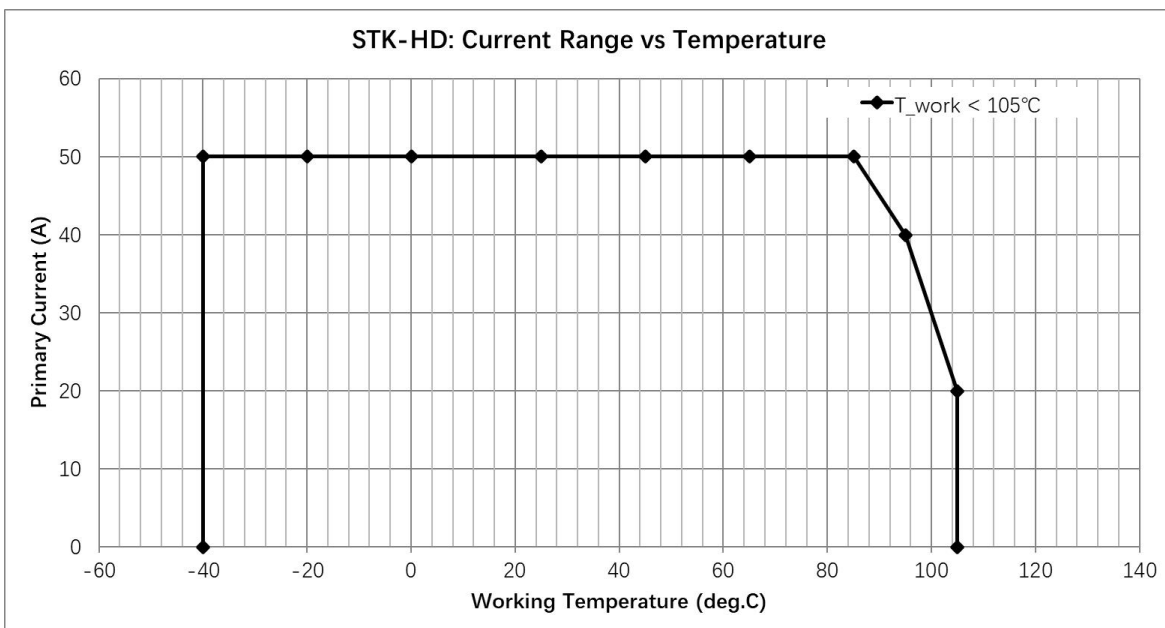
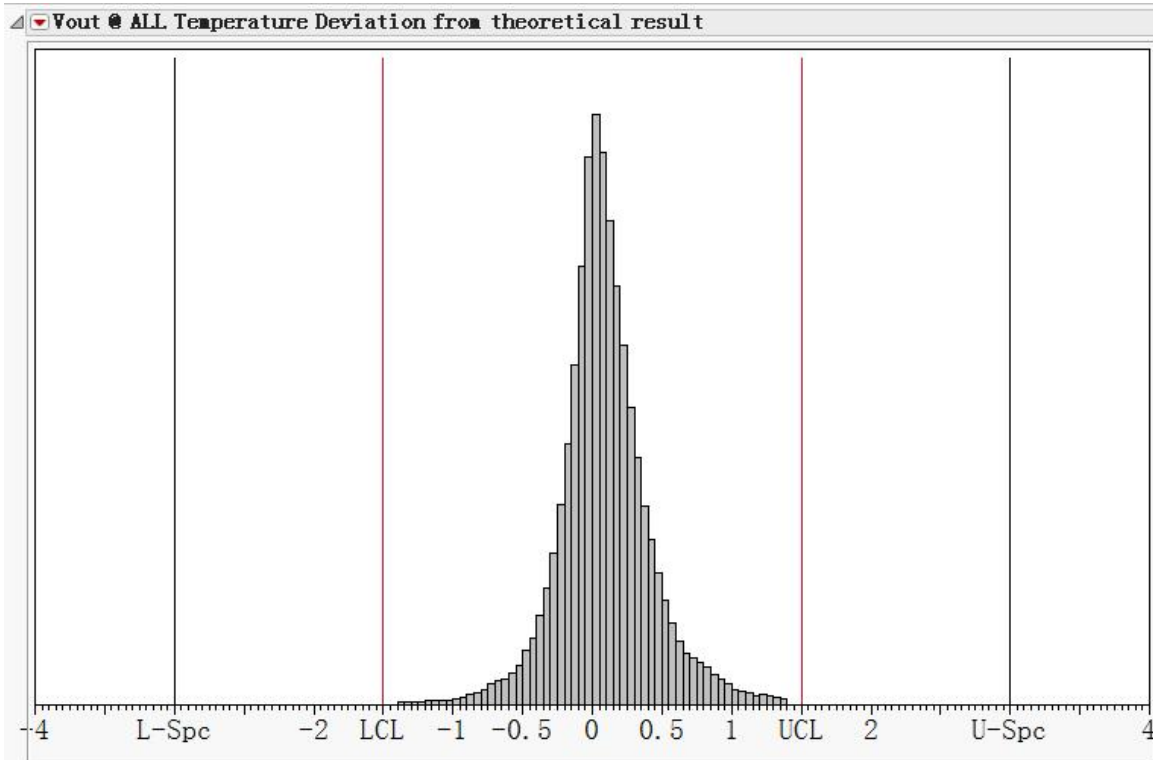

Fig.4 When the primary current is applied to the product, the temperature of the product is measured by build-in temperature sensor. The limitation on the primary at different working/ambient temperature is that the product's temperature sensed by build-in temperature sensor not exceeds 105°C.

The testing setting: a product is put into a high/low temperature chamber, which equipped fan to maintain the temperature in the chamber.

It should be noted that the temperature rise may different from the curve listed above if a different cooling method was used.

## 24. Accuracy performance



The error of  $(V_{out} - V_{ref})$  (for STK-20HD/Px) or  $(V_{out} - V_{refc})$  (for STK-20HD/PxS) current sensors in the temperature range of  $-40^{\circ}\text{C} \sim 105^{\circ}\text{C}$  compared with the standard output ( $V = G_{th} * I_n$ ).

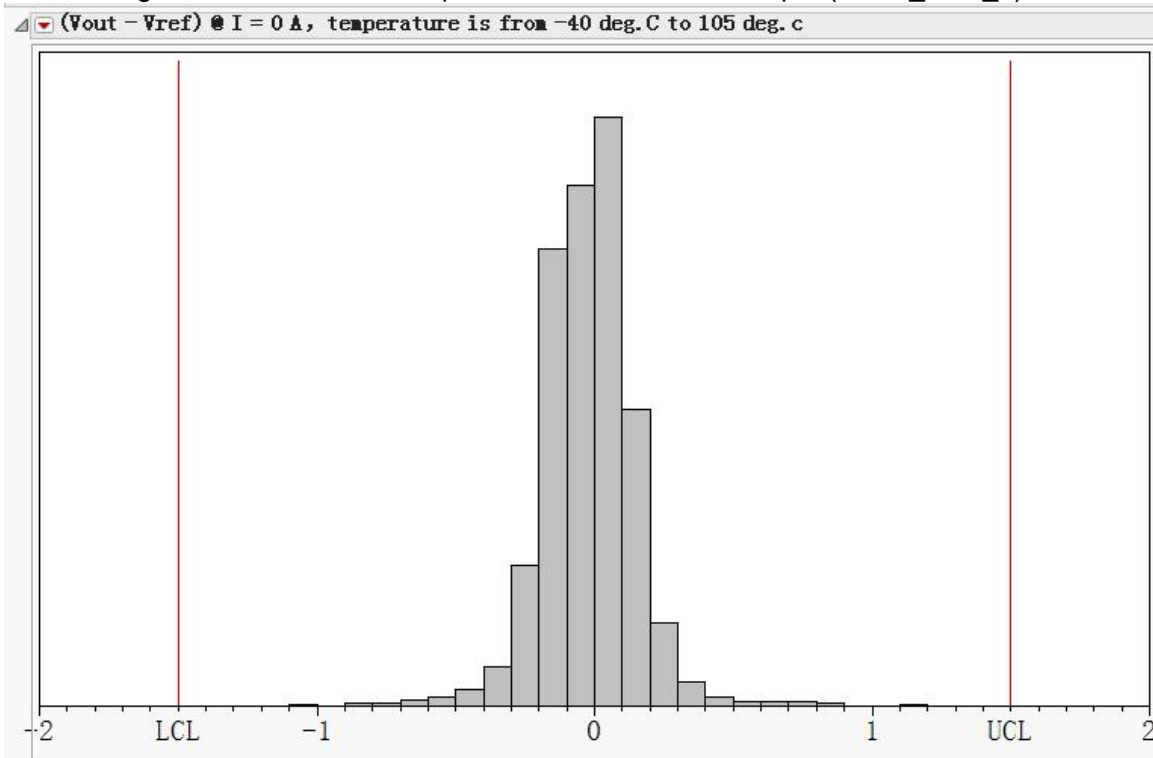

Temperature drift of  $V_{oe}$ ,  $V_{oe\_TRange} = (V_{oe} @ T_x - V_{oe} @ 25^{\circ}\text{C}) / V_{FS}$ .  $T_x$  represents present temperature,  $V_{FS}$  the rated output voltage.



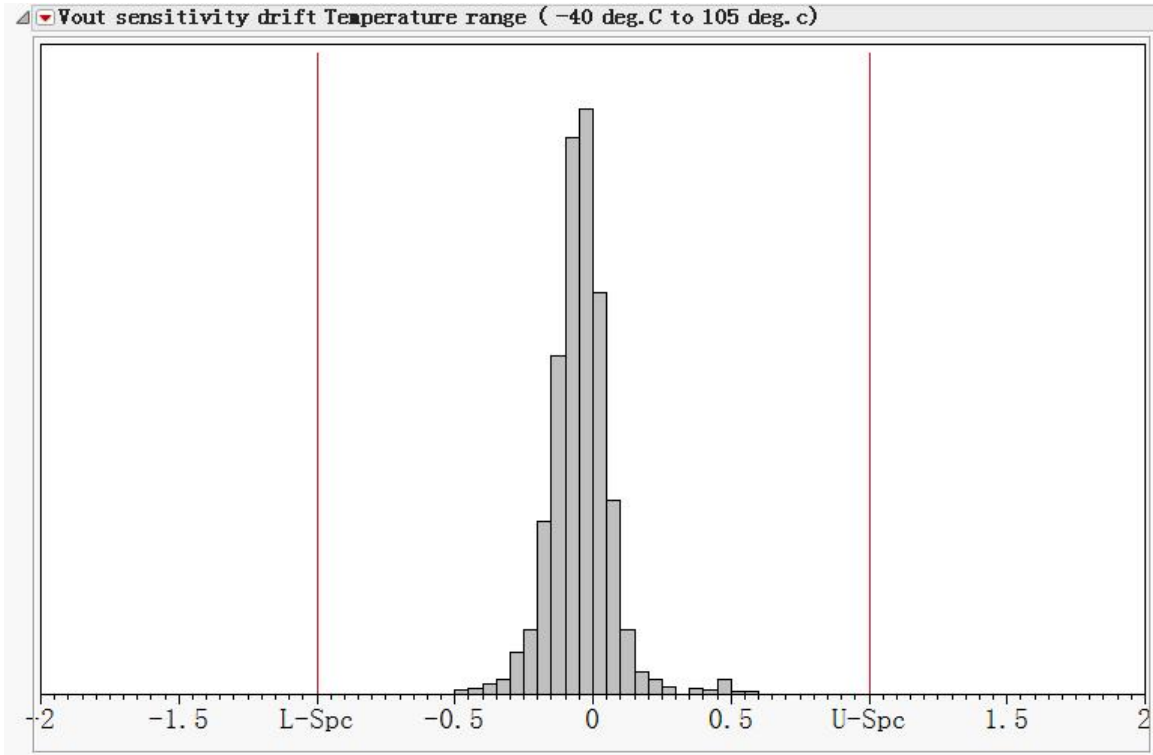

The error of gain at room temperature

## 25. Typical application circuits for STK-HD/Px

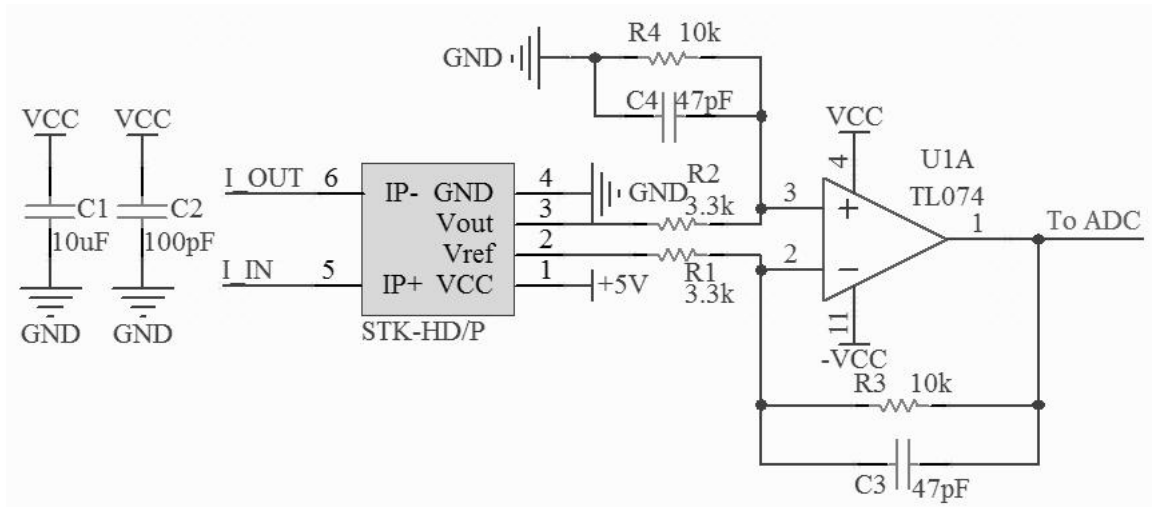

Typical application circuits for STK-HD/P1& STK-HD/P2 current sensor. The magnification can be estimated as  $M = R4/R2$  with the condition of  $R1 = R2$ , and  $R3 = R4$ . The magnification in the above circuit is about 3.

$R3$ (kohm) = $R4$ (kohm)	$C3$ (pF) = $C4$ (pF)	Theoretical -3dB $f = 1/(2\pi RC)$ (kHz)	Tested -3dB (kHz)
20	20	398	~400
20	81	98	~100
20	810	10	~10

The frequency characteristics of STK\_HD series current sensor are not affected by the R-C setting (according to recommended R-C setting), therefore the active filter circuit or R-C circuit can be applied to modulate the sensor's frequency characteristics.

## 26. Typical application circuits for STK-HD/PxS

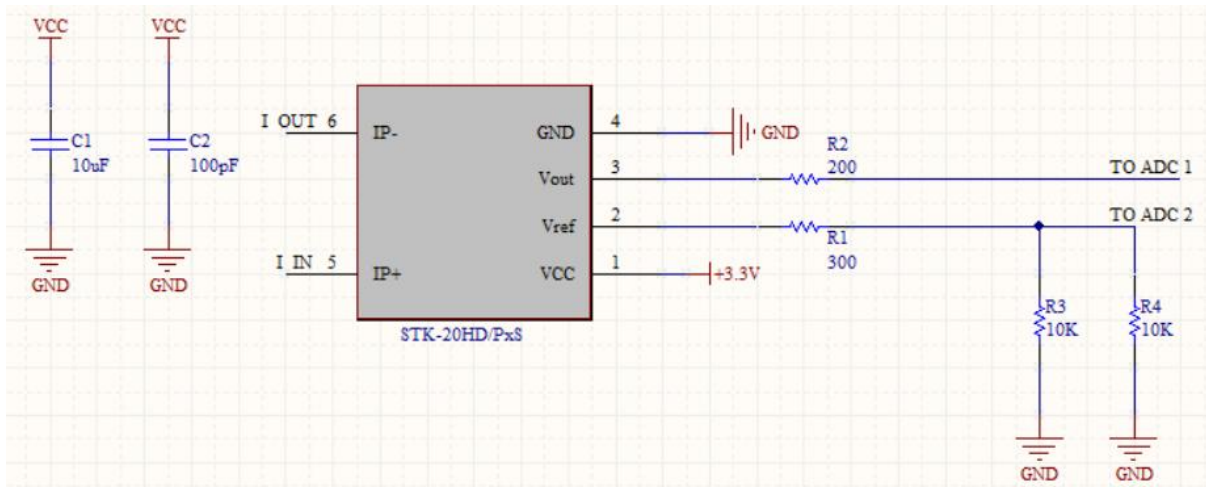

Typical application circuits for STK-HD/P1S& STK-HD/P2S current sensor. A division voltage of 1.65 V can be obtained through series resistor (R1, R3, R4).

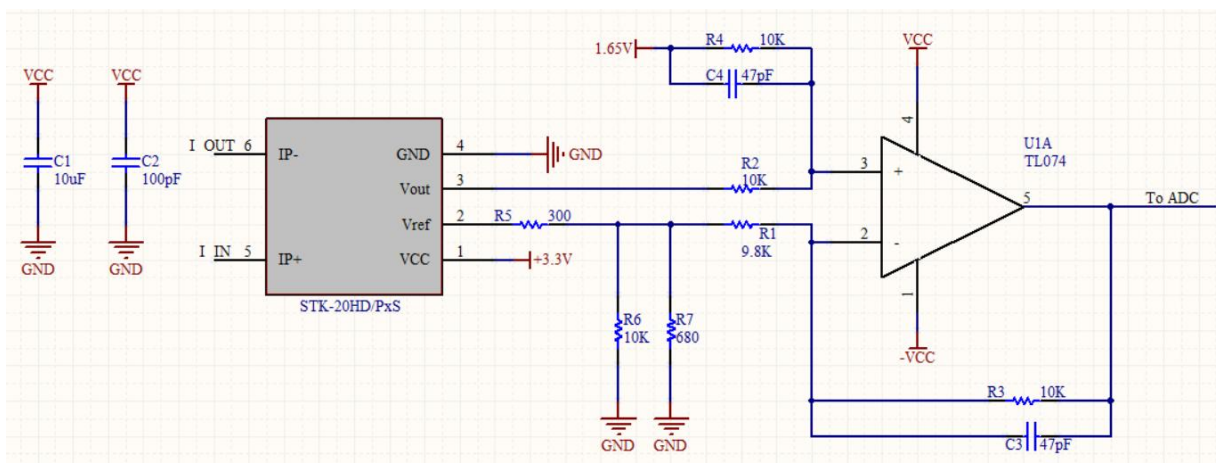

Typical application circuits for STK-HD/P1S& STK-HD/P2S current sensor. The magnification can be estimated as  $M = R4/R2$  with the condition of  $R1 = R2$ , and  $R3 = R4$ . The magnification in the above circuit is about 1. A division voltage of 1.65 V can be obtained through series resistor (R5, R6, R7).

$R3$ (kohm) = $R4$ (kohm)	$C3$ (pF) = $C4$ (pF)	Theoretical -3dB $f = 1/(2\pi RC)$ (kHz)	Tested -3dB (kHz)
20	20	398	~400
20	81	98	~100
20	810	10	~10

The frequency characteristics of STK\_HD series current sensor are not affected by the R-C setting (according to recommended R-C setting), therefore the active filter circuit or R-C circuit can be applied to modulate the sensor's frequency characteristics.

## 27. Dimensions & Pins & Footprint

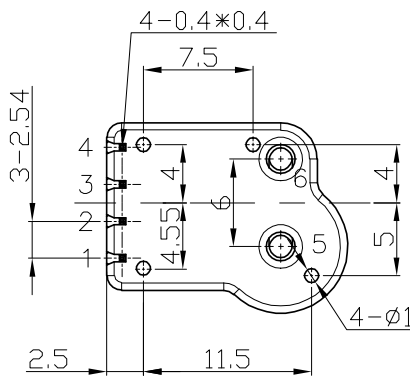
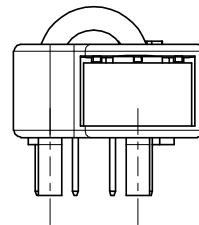
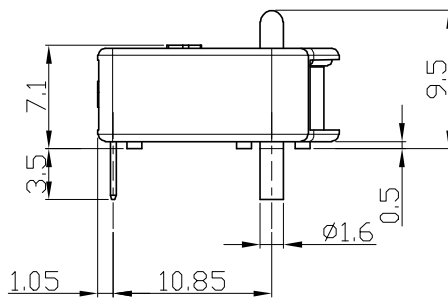
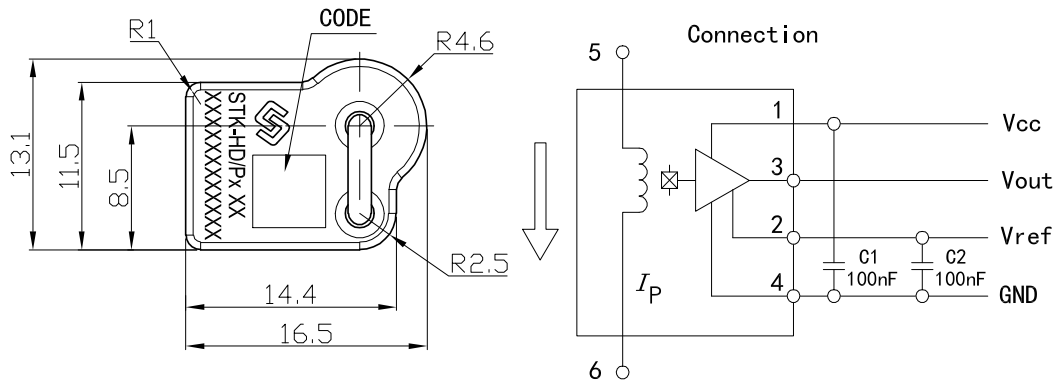

Terminals

1.	Vcc
2.	Vref
3.	Vout
4.	GND
5.	I <sub>p</sub> <sup>+</sup>
6.	I <sub>p</sub> <sup>-</sup>

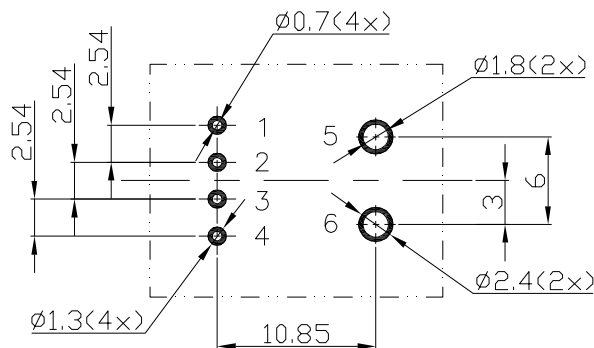

Material : Fit UL94V-0 & RoHS requirements ;  
General tolerance :  $\pm 0.5$   
Unit :mm

